

**Ceiling unit  
Pureline Compact 120 cm  
Mineral Black**

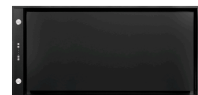

EAN 5414425195466

**Energy label**

▪ Energy Efficiency class (EEIhood)	B
▪ Annual Energy Consumption (kWh/year) (AEChood)	67,4
▪ Fluid Dynamic Efficiency class (FDEhood)	B
▪ Lighting Efficiency class (LEhood)	C
▪ Grease Filtering Efficiency class (GFEhood)	D

**Functions & features**

▪ Motor	Integrated
▪ Sound absorber	Integrated
▪ Recirculation	Optional
▪ InTouch function	Standard
▪ Auto stop	▪
▪ Delayed switch off (minutes)	10/30
▪ Grease filter	6830020
▪ Number of grease filters	2
▪ Grease filter cleaning indication	▪
▪ Recirculation filter cleaning indication	▪
▪ Control method	Push buttons + Remote control
▪ Number of speeds	3 + power
▪ Automatic Power revert (minutes)	6

**Dimensions**

▪ Product dimensions (WxDxH) (mm)	1168 x 508 x 195
▪ Height incl. mounting clamps (without motorbox) (mm)	133
▪ Width flange (mm)	15
▪ Dimensions cut-out opening (WxD) (mm)	1145 x 485
▪ Advised mounting height induction hobs (Hmin-Hmax) (mm)	600 - 1600
▪ Advised mounting height gas hobs (Hmin-Hmax) (mm)	650 - 1600
▪ Advised mounting height ceramic hobs (Hmin-Hmax) (mm)	600 - 1600
▪ Diameter outlet (mm)	222x89
▪ Position exhaust	Right, Left, Front, Back

**Lighting**

▪ Functional lighting type	LED
▪ Functional light dimmable	▪
▪ Soft-ON/OFF	▪
▪ Number of functional lights	4
▪ Total energy consumption functional light (W)	12
▪ Color functional light (K)	2700/4000

**Airflow and noise level**

▪ Free airflow (m³/h)	750
-----------------------	-----

## Airflow and noise level

---

- Airflow (m<sup>3</sup>/h) measured according to EN 61591
- Sound regulation according to DIN 45635-2
- Airflow duct out speed 1 (m<sup>3</sup>/h) / Max pressure duct out speed 1 (Pa) 240 / 40
- Airflow duct out speed 2 (m<sup>3</sup>/h) / Max pressure duct out speed 2 (Pa) 444 / 140
- Airflow duct out speed 3 (m<sup>3</sup>/h) / Max pressure duct out speed 3 (Pa) 582 / 265
- Airflow duct out max powerspeed (m<sup>3</sup>/h) (Qboost) / Max pressure duct out max powerspeed (Pa) 651 / 484
- Sound pressure duct out speed 1 (dB(A)) / Sound power duct out speed 1 (dB(A)) 27 / 38
- Sound pressure duct out speed 2 (dB(A)) / Sound power duct out speed 2 (dB(A)) 40 / 52
- Sound pressure duct out speed 3 (dB(A)) / Sound power duct out speed 3 (dB(A)) 47 / 59
- Sound pressure duct out at max powerspeed (dB(A)) / Sound power duct out at max powerspeed (dB(A)) (LWAbost) 51 / 63

## Technical specifications

---

- |   |      |
|---|------|
| ▪ Maximum power (W)                           | 171  |
| ▪ Voltage cooker hood (V)                     | 230  |
| ▪ Frequency (Hz)                              | 50   |
| ▪ Power consumption in stand-by-mode (Ps) (W) | 0.25 |
| ▪ Net weight (kg)                             | 22   |
| ▪ Length power supply cable (m)               | 1,2  |

1

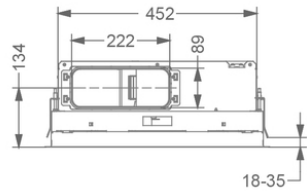

2

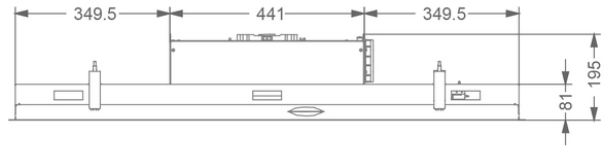

3

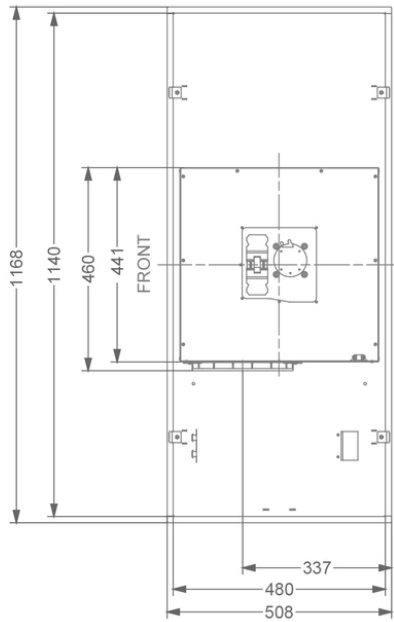

4

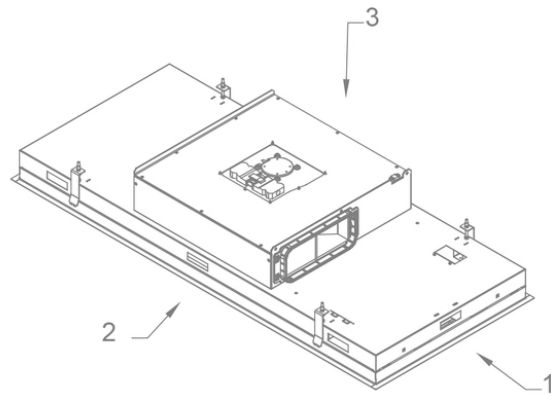

## Accessories

## Recirculation box



841400

recirculation box with monoblock white (270x500mm)



842400

recirculation box with monoblock (270x500mm)



843400

recirculation box with monoblock grey (270x500mm)

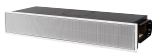

7931400

Recirculation box white with monoblock, H140 mm



7932400

Recirculation box with monoblock, H140 mm

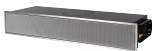

7933400

Recirculation box grey with monoblock, H140 mm

## Control kit



990030

Control kit for external lighting or valve

